

# REPAIR MANUAL

*Alfetta*



REPLACEMENT OF  
WINDSCREEN AND REAR SCREEN



*This publication  
is intended for the ALFA ROMEO Service Organisation  
and contains instructions for replacing windscreen and rear screen  
on the Alfetta.*

*The operations are fully illustrated,  
in order to identify the parts in question,  
the tools to be used and the correct method to be followed.*

*When replacing parts,  
only genuine ALFA ROMEO spare parts must be used,  
as only these ensure complete interchangeability and perfect operation  
of the various units.*

*When ordering, please indicate  
the type of car, the part number quoted in the Parts Catalogue, chassis serial number  
and the engine serial number.*

*When replacing screens, the use of our special equipment is also recommended.*

*Finally, this Manual should always be kept up to date  
with the data and information issued by means of the "Information Sheets" and the "Up-dating-Instructions"  
which are issued periodically by our Technical Service Department.*

*Alfa Romeo* Service Department



## INDEX

- 1 Introduction
- 3 Windscreen and rear screen
- 4 Recommended materials, equipment, sealants and liquids.
- 5 Replacing the windscreen
- 11 Replacing the rear screen



## WINDSCREEN AND REAR SCREEN

Both windscreen and rear screen are bonded directly into the aperture's by means of sealing compound.

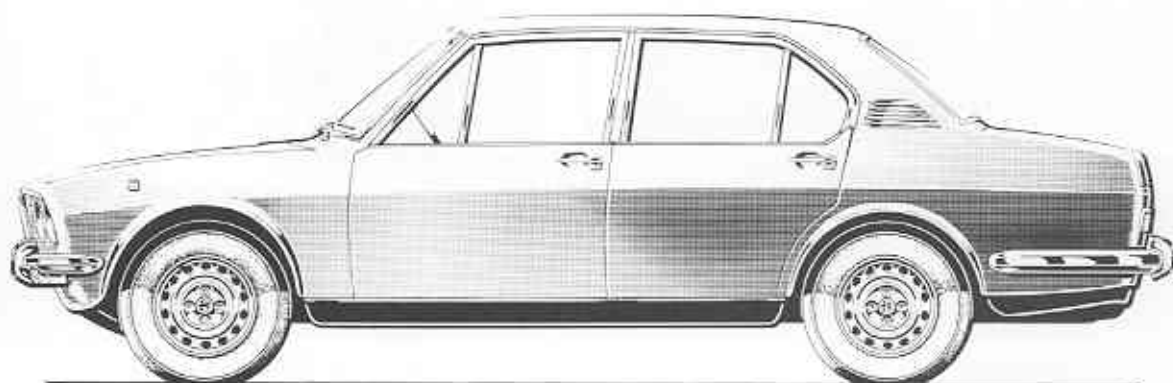
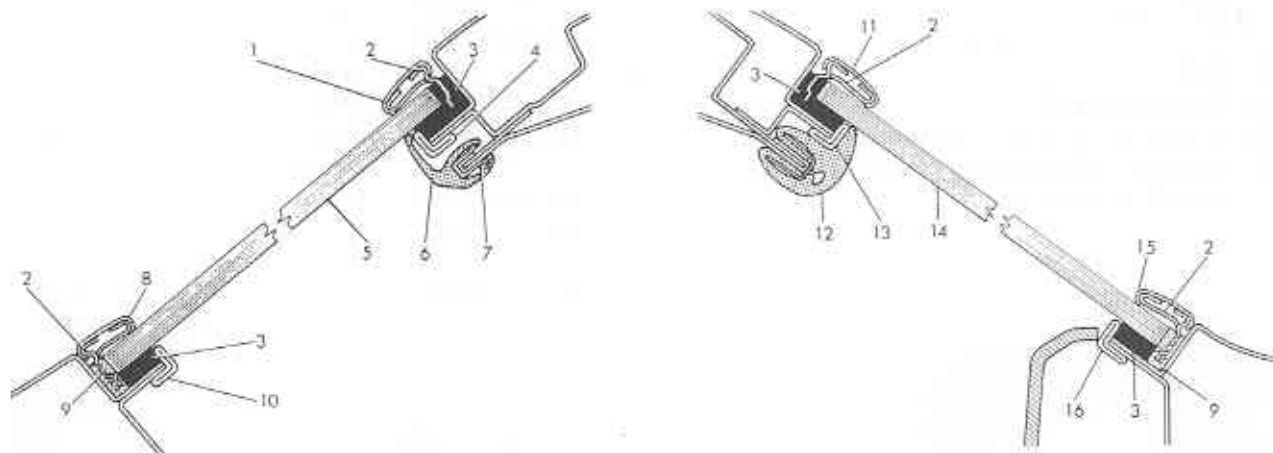

- 1 - Upper finisher, outer
- 2 - Retaining clips for finisher
- 3 - Sealant for windscreen
- 4 - Upper spacer
- 5 - Windscreens
- 6 - Inner finisher
- 7 - Retaining clips for inner finisher
- 8 - Lower finisher, outer

- 9 - Magnetic spacer
- 10 - Lower spacer
- 11 - Upper finisher, outer
- 12 - Inner finisher
- 13 - Upper spacer
- 14 - Rear screen
- 15 - Lower finisher, outer
- 16 - Lower spacer



## MATERIALS

The materials required to carry out the removal and fitting of one screen are supplied in kit form under Part. no. 116.08.61.806.00. This kit contains:

- 1 - Mixing spatula
- 2 - Extrusion cartridge
- 3 - Basic sealing compound
- 4 - Retaining clips
- 5 - 4 mm. and 5.5 mm. magnetic spacers
- 6 - Catalyst for sealing compound
- 7 - Scouring solution

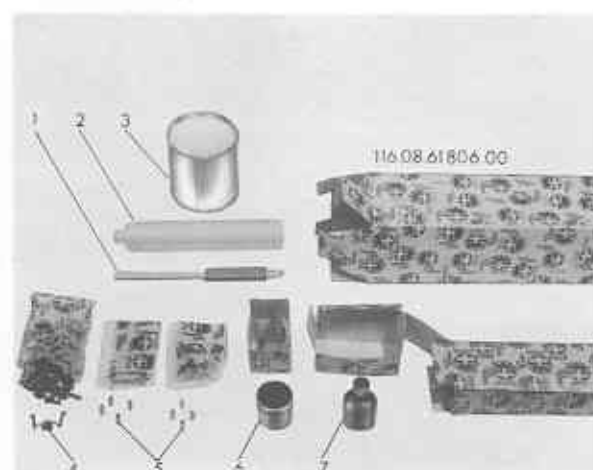

## EQUIPMENT

The equipment required for the various operations is as follows:

- 8 - G. 9.0003 - Straps for pressing down rear screen
- 9 - G. 9.0001 - Suction pads (2 off)
- 10 - G. 9.0002 - Strap for pressing down windscreen
- 11 - A. 9.0060 - Removal tool for screens
- 12 - A. 9.0064 - Removal tools for exterior finishers
- 13 - G. 9.0061 - Cleaning tool for screens
- 14 - G. 9.0010 - Gun with nozzle for extruding sealant
- 15 - G. 9.0011 - Spare nozzle with nozzle carrier for gun

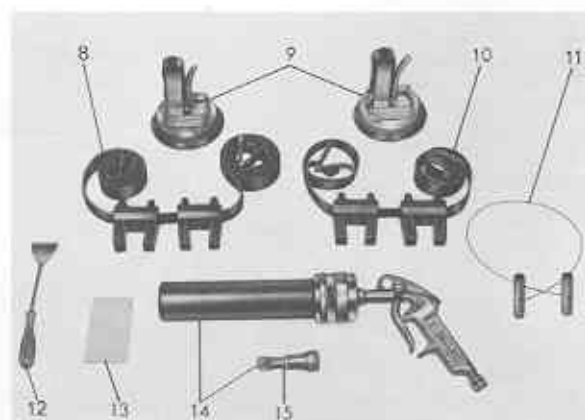

## RECOMMENDED SEALING COMPOUNDS AND SOLUTIONS

DESCRIPTION	RECOMMENDED COMMERCIAL EQUIVALENTS				
	I.C.I.R.	D E B	I C A D	GALBIATI	MINNESOTA 3M
Sealing compound for: - windscreen and rear screen internal distance mouldings. PS: Degrease the metal surfaces to be jointed, using methylethyl alcohol. - texalfa covering edge of front pillars. - covering edge of rear shelf.	Pluricolla Beta SPM	B 205/AF	Carstik 0,5	-	-
- windscreen and rear screen to metal surface of aperture. Mix { Basic solution Catalyst PS: Degrease the edge surfaces of the screens using methylethyl alcohol.	-	-	-	Thioprene P 116 C 116/L	-
Scouring solution (Primer) for: - Perimetral edge surfaces of windscreen and rear screen	-	-	-	P/SM	-
Sealant to prevent seepage of water through screen fixing area	2214	-	-	-	Ribbonseal 3M



## REPLACING WINDSCREEN

Withdraw cap 1 from wiper arm securing nut. Release and remove securing nut. Withdraw wiper arm. Remove the opposite wiper in a similar manner.

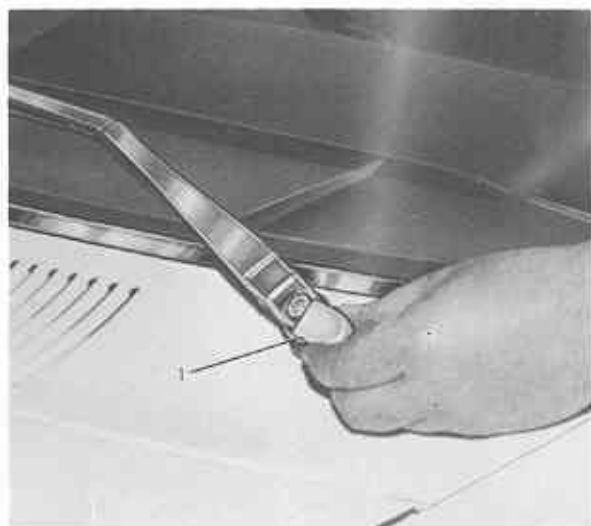

Insert tool no. 2 (A. 9.0064) near one of the corners of the windscreen. Raise the finisher 3 and unhook it from the retaining clips 4. Remove joint cover 5 from the finishers. Repeat this operation along the entire perimeter of the finisher until it is completely detached.



Using screwdriver and pliers, remove from the sealing compound in the groove between screen and metal surface the 24 retaining clips 4 and the 2 magnetic spacers 6 arranged on the lower edge of the aperture, and corresponding with the outer ends of the upper air intake.

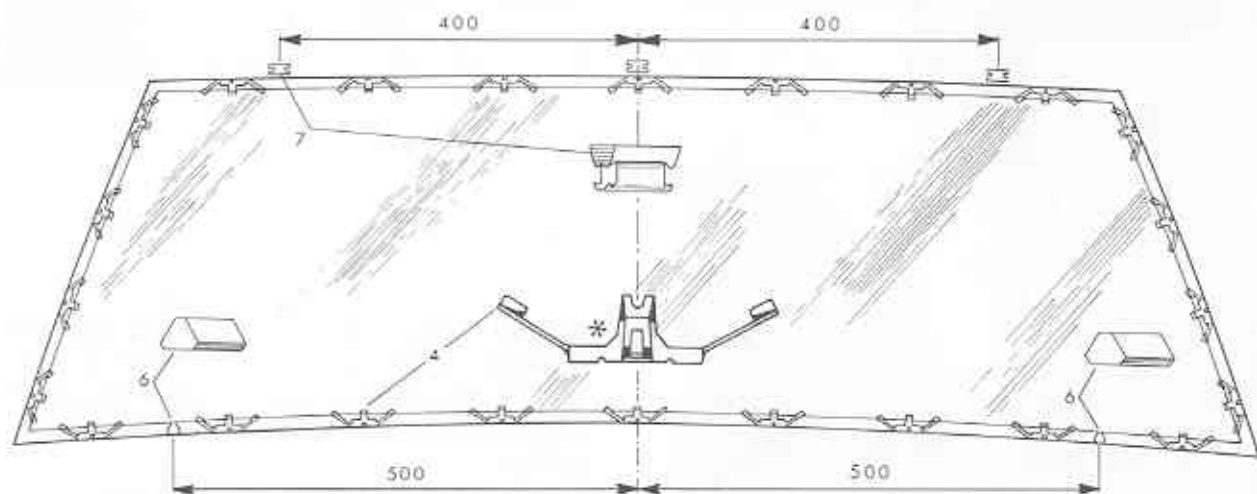

\* Total number of retaining clips 24, arranged equidistant on each side.



Remove rear view mirror and upper windscreen trim finisher, together with the corresponding retaining clips 1.

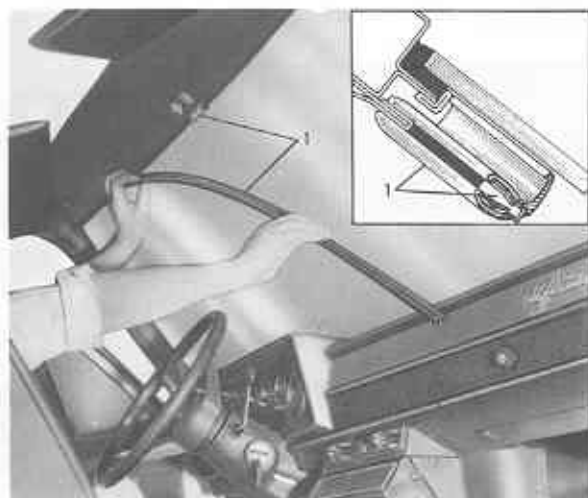

From the door aperture, remove moulding 2 which is fitted on the edge of the pillar trim. Lift the Texalfa strip 3 and separate from metal surface. Release and remove the screws 4 and the trim. Repeat operation on opposite side.

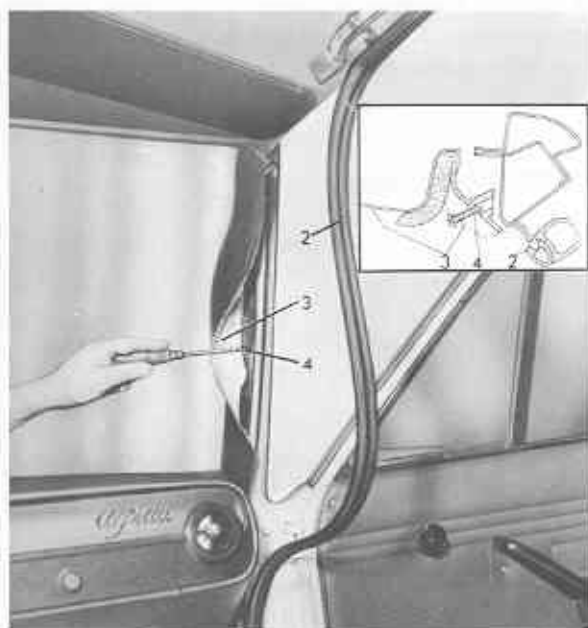

Free from the handle of tool 5 (A. 9.0060) one end of the steel cable 6. Pierce the adhesive sealant, inserting the cable near a corner of the screen. Fix the cable again to the handle of the tool.

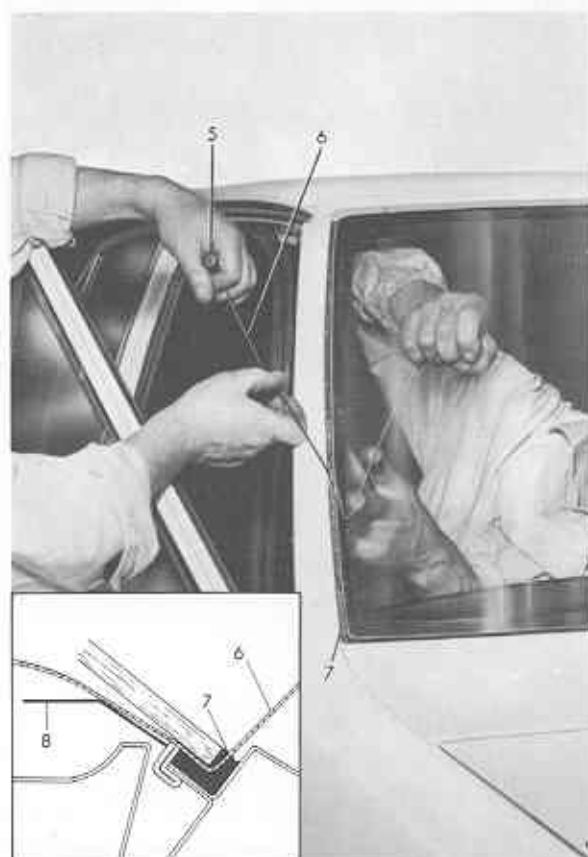

Protect front edge of instrument pinnacle adjacent to the screen with a piece of metal 8. Cut the adhesive bead 7 along the screen edge, moving the cable with a reciprocating action. On completion of this operation remove this glass.



Remove windscreen spacer mouldings 1 from the top, bottom and sides of the aperture. Protect the front edge of the instrument-pinnacle adjacent to the windscreen, and using a sharp blade, carefully remove the adhesive 2 left on the metal surface. Degrease the entire area using cloth soaked in methylethyl alcohol.

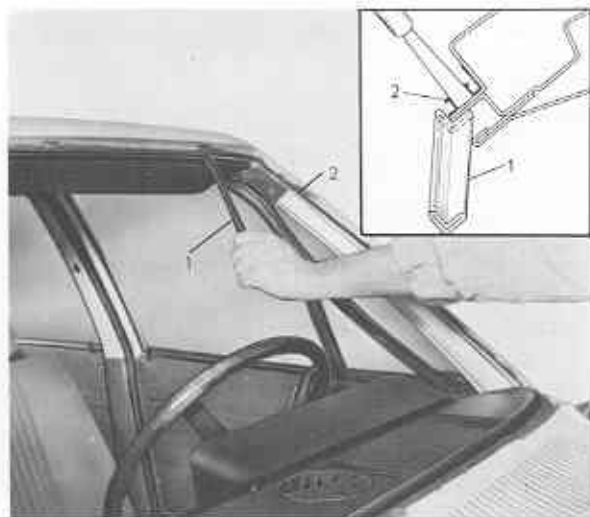

Brush the recommended Primer to the groove of the new windscreen space moulding and to the corresponding areas of the metal surface of the pillars and to the header panel. After the Primer has set, fit moulding 3 to the edges in the aperture.

Cut ends, if these are too long.

**NOTE:** In order to improve adhesion, press at first the lower spacer moulding against the metal surface, using wood wedges 4. Remove wedges after approx. 10 minutes.

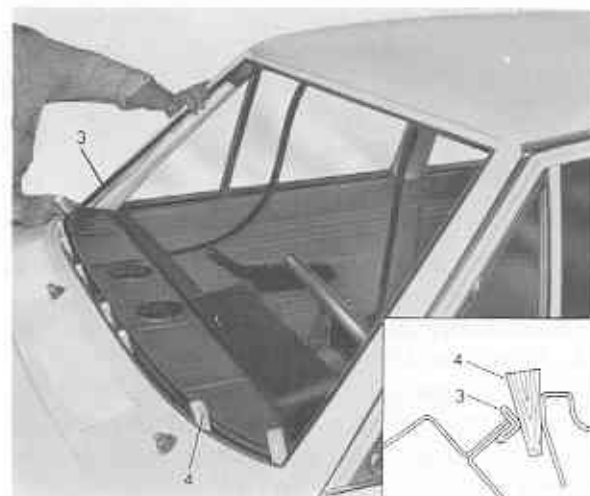

Position the retaining clips 5 for the top internal finisher 6 and clip them onto the panel, using a mallet. See page 5, ref. 7. Fit moulding and clip it in position, using a mallet, on the retaining clips previously fitted, and also over the panel of the windscreen aperture.



Fit trim 7 to the two windscreen pillars and secure with screws.

Apply the recommended adhesive to the Texalfa edge 8 of the trim and secure to the edge of the door aperture. Subsequently fit moulding 9 in position.

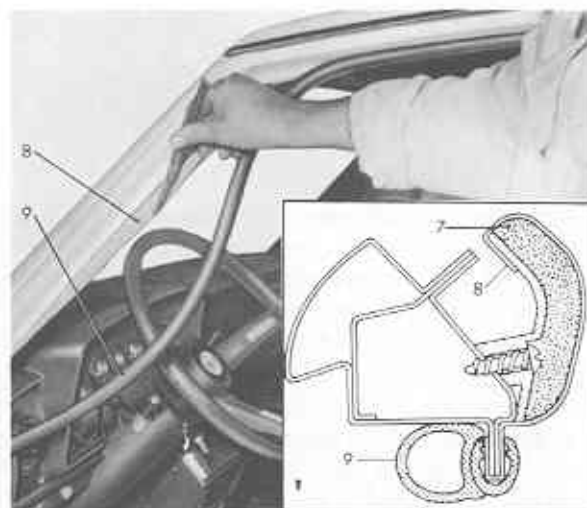





Prepare the panel on the outside area of the windscreen aperture by brushing the recommended scouring solution onto surface 1. Allow approx. 10 minutes to dry.



Degrease the inner perimeter of the glass, using cotton wool soaked in methylethyl alcohol.

**NOTE:** Where the original glass is used, all of adhesive must be removed from its internal perimeter, using spatula 13 (G. 9.0061), see page 4, before the above degreasing operation can be carried out.

Position the two magnetic spacers 5 for seating and centering the screen on the lower edge of the screen aperture, in line with the outer ends of the upper air intake louvers. Fit the suction pads 6 (G.9.0001) to the screen and ensure that it is central in the aperture. If necessary, replace previously fitted spacers with spacers of the appropriate thickness. Minimum clearance on the perimeter between screen and panel: 4 mm.

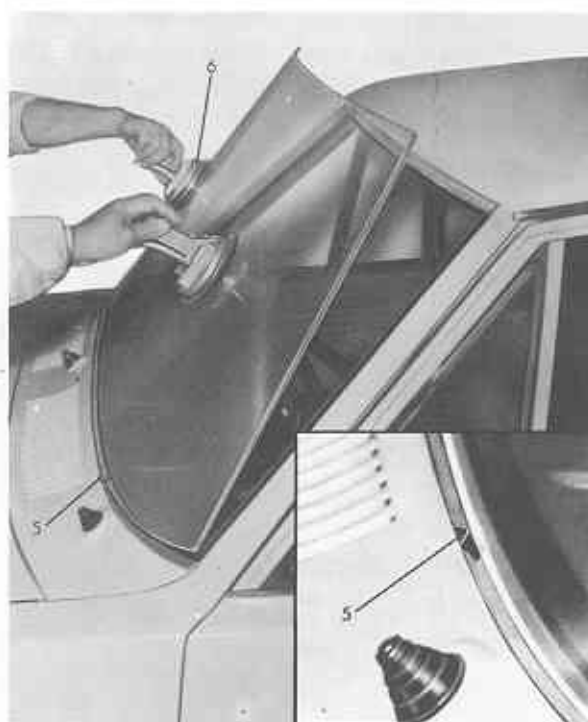

Prepare the recommended adhesive for bonding the windscreen, by mixing the two components - Catalyst A and Basic solution B - for approx. 8 to 10 minutes, until a homogeneous paste is obtained.

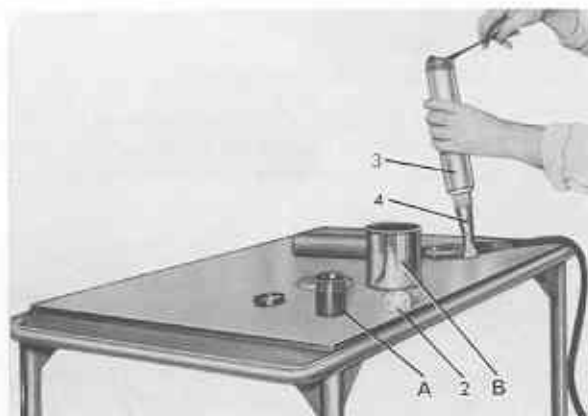

**NOTE:** The compound must be used within 30 to 40 minutes of mixing.

Remove the plastic plunger 2 from the gun 3. Fit nozzle 4 to cartridge.

Using a spatula, fill the cartridge with paste, turning the cartridge to avoid air bubbles being formed. Insert the plastic plunger in the cartridge with its hollow part outwards.



Load the gun 1 (G. 9.0010) with the filled cartridge. Connect it to the air line and set the pressure to 3 to 4 Kg/sq. cm. (44 to 59 lb. sq. in).

Insert the nozzle 2 in the groove between screen and panel. Open air supply and moving the gun along the groove, fill up accurately the groove.

Finally, remove the suction pads from the screen.

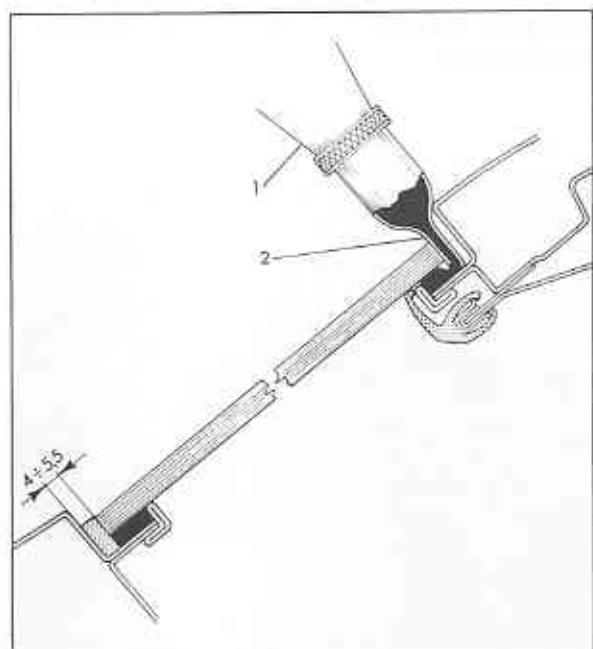

Press the screen in the aperture, using the adjustable strap 3 (G.9.0002), suitably anchored to the pillars. After approx. 30 minutes, fit the 24 retaining clips 4 for the exterior



finisher to the adhesive bead, and arrange as shown at illustration on page 5.

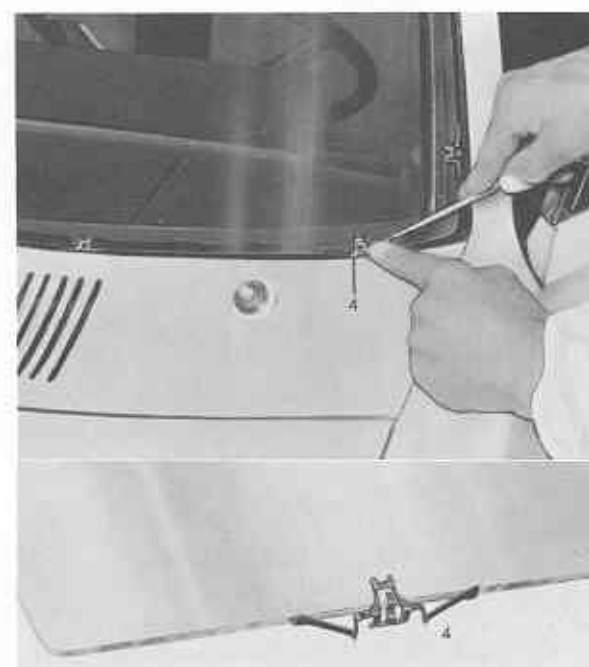



**WARNING:** The adhesive should be left to harden at room temperature for 6 to 8 hours, or for 12 to 16 hours during the winter, At temperatures of 80°C the hardening is completed with 60 minutes.

The car may be placed in a low bake oven at the above temperature, taking into account The following:

- Drain petrol from tank
- Remove filler cap from petrol tank and cover the filler pipe with a paper cap that comprises a breather slot.
- Lower tyre pressure
- Remove battery
- Protect windscreen with asbestos.

Remove the windscreen compression strap and scrape any excess adhesive from the areas where the finisher is to be fitted.

Carry out the water test. Any ingress of water can be rectified by application of the recommended sealant.

If undamaged, position and hook the upper and lower exterior finishers onto the retaining clips, leaving their ends free, hook in the centre only the outer lateral finishers to the retaining clips. Lift the ends of the finishers and fit the joint covers 1. Complete the clipping of the finishers.



Refit windscreen wiper arms to their spindles, with the blades arranged parallel to the bottom finisher. Fit locking washer and nut. Lock nut and fit protection cap.

Repeat the windscreen wiper fitting operation on the opposite side. Fit interior mirror.



## REPLACEMENT OF REAR SCREEN

Release and remove the wing nuts fixing the rear seat squabs. These are located on the bulkhead of the luggage boot. Remove rear seat and squab.

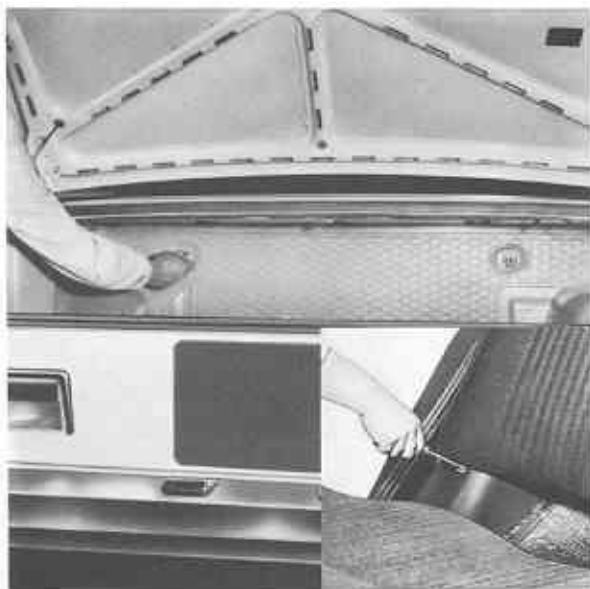

Lift padded Texalfa strip, unscrew the three screws fixing the rear shelf and remove the shelf.



Remove the upper and side finishers 1 from rear screen surround.

**NOTE:** Where a heated rear screen is fitted, disconnect the two ends 2 of the electrical cables located on the rear pillars.

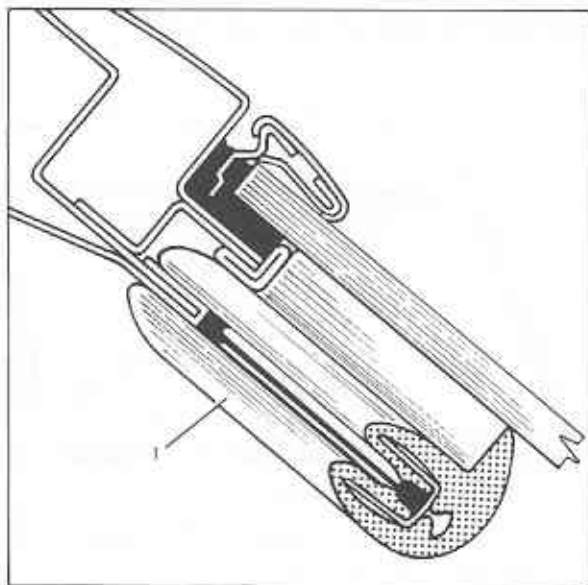
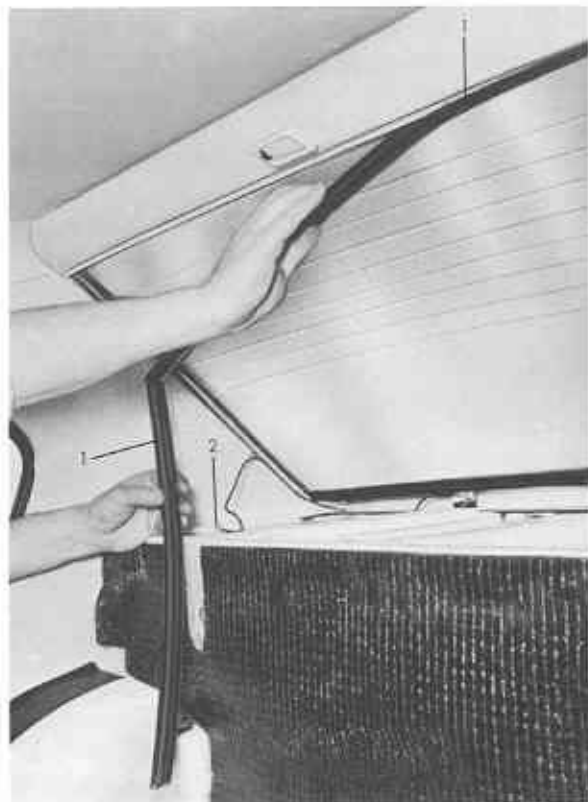



Apply tool 1 (A. 9.0064) near a corner of the screen and lift the finisher 2, unclipping it from clip 3. Withdraw joint cover 4 from the finisher. Continue with this operation along the entire perimeter of the finisher, until it is completely detached.

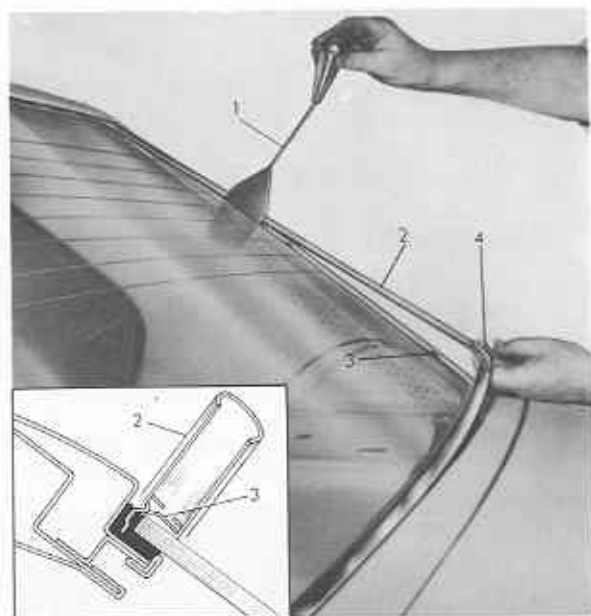

Using a screwdriver and pliers, remove the 17 retaining clips 5 from the sealing compound in the groove between screen and panel. Remove also the two magnetic spacers 6 located on the bottom edge of the aperture.

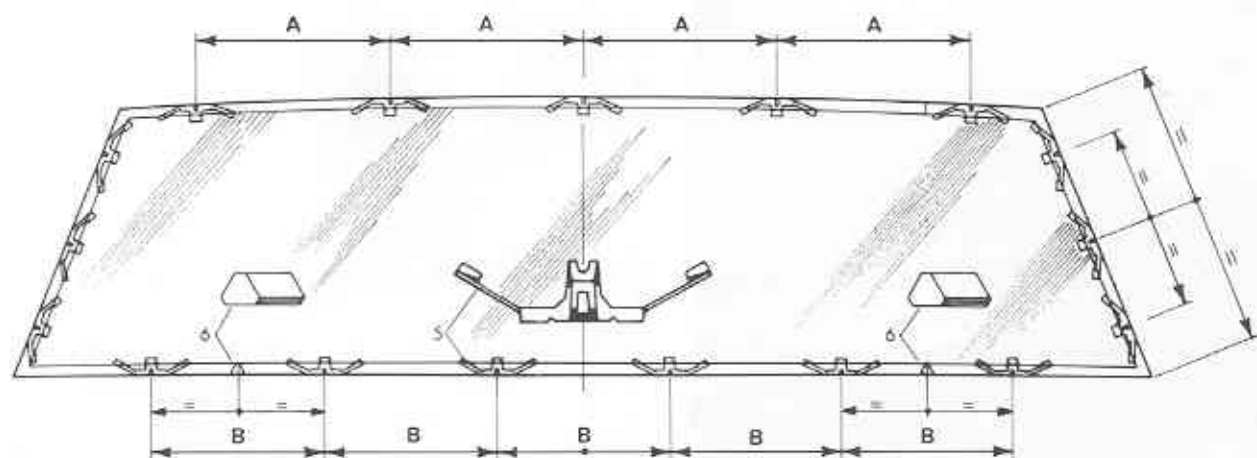

A = mm 225; B = mm 200

Release one end of the steel cable from the handle of tool 7 (A. 9.0060). Pierce the bead of adhesive 8 by inserting the steel cable in one of the corners. Lock the end of the cable onto the handle.

Cut the bead of adhesive 8 along the perimeter of the screen by means of alternating motion of the cable. On completion of this operation remove this glass.





Remove the screen spacer moulding **1** from the upper and lower sides.

Using a sharp blade, carefully remove the adhesive **2** left on the panel. Degrease the area with cloth soaked in methylethyl alcohol.

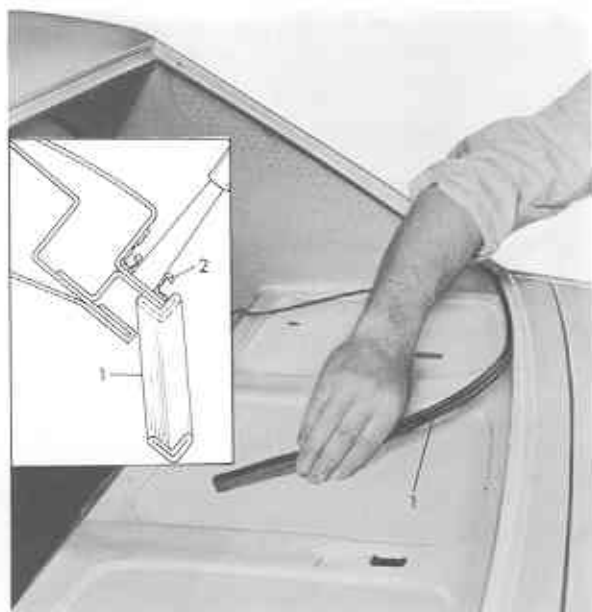

Apply the recommended sealant, using a brush in the groove of the new bottom and top spacer mouldings and also onto their joint faces. After allowing the sealant to set, assemble mouldings onto the edges of the aperture. Cut off any excess length.

Fit upper and lateral interior finisher **3**, forcing it onto the support panel in the aperture.

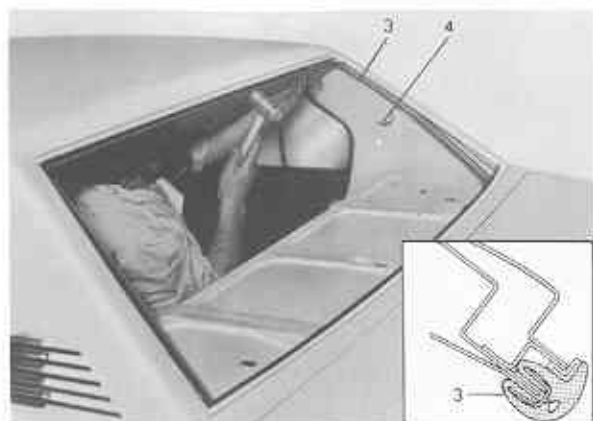

**WARNING:** On cars fitted with a heated rear screens insert the two electric cables into the groove of the side finisher, allowing their ends **4** to protrude from the special holes provided in the finisher.

Prepare the panel along the perimeter of the screen aperture for the adhesive, by brushing scouring solution onto the areas to be covered by adhesive **5**. Allow approx. 10 minutes for drying.

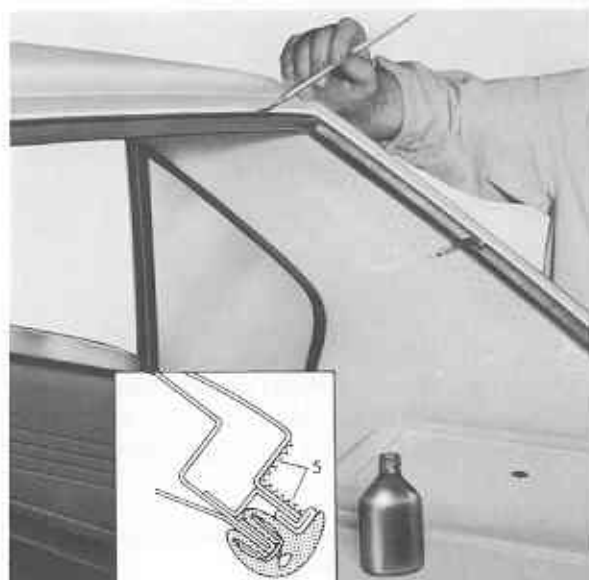

Degrease the inside perimeter of the rear screen with cotton wool soaked in methylethyl alcohol.

**NOTE:** Where the old screen is to be refitted, any traces of adhesive should be removed from the inside perimeter of the screen, using spatula 13 (G. 9.0061), before the degreasing operation can be carried out. See page 4.



Arrange the two magnetic spacers 4, used for supporting and centralizing the screen, on the bottom edge of the aperture.

Fit the suction pads 5 (G. 9.0001) onto the screen and fit the screen in the aperture. Ensure that it is central. If necessary, replace the previously fitted spacers with spacers of a suitable thickness. Minimum clearance on the perimeter between screen and aperture: 4 mm.

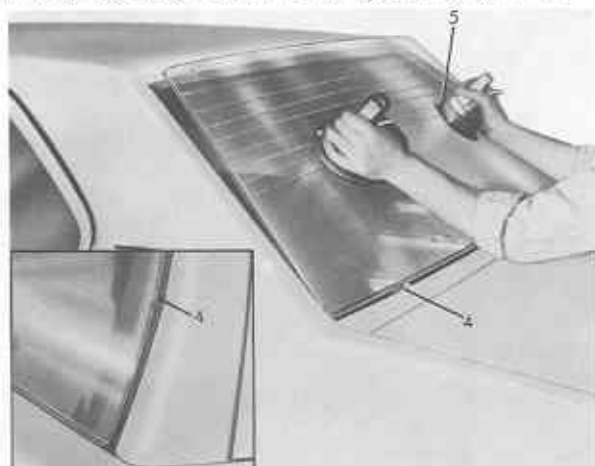

Prepare the recommended adhesive by mixing catalyst A and basic material B for approx. 8 to 10 minutes, until a homogeneous paste is obtained.

**NOTE:** The adhesive must be used within 30 to 40 minutes of having been mixed.

Remove plastic plunger 1 from cartridge 2. Apply nozzle 3 to the end of the cartridge.

Using a spatula, fill the cartridge with the paste previously prepared avoiding the formation of air bubbles. Insert the plastic plunger in the cartridge with its concave face outwards.

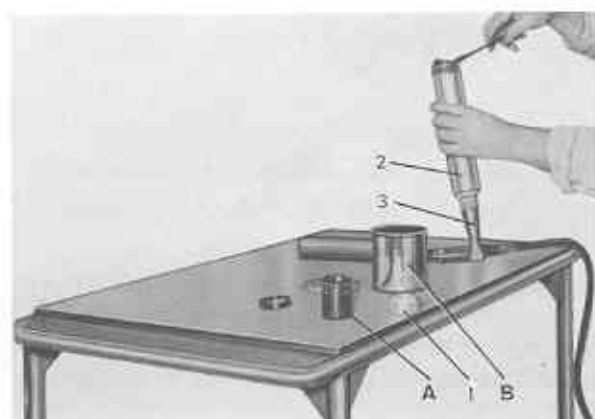

Fit cartridge 6 (G. 9.0010) to the gun. Connect air line and adjust pressure to 3 to 4 kg/sq. cm. (44 to 59 lbs. sq. in.).

Insert nozzle 7 of the gun in the groove between screen and panel. Apply air pressure. Move gun along the groove and fill the perimetral groove carefully. On completion, remove the suction pads 5 from the screen.

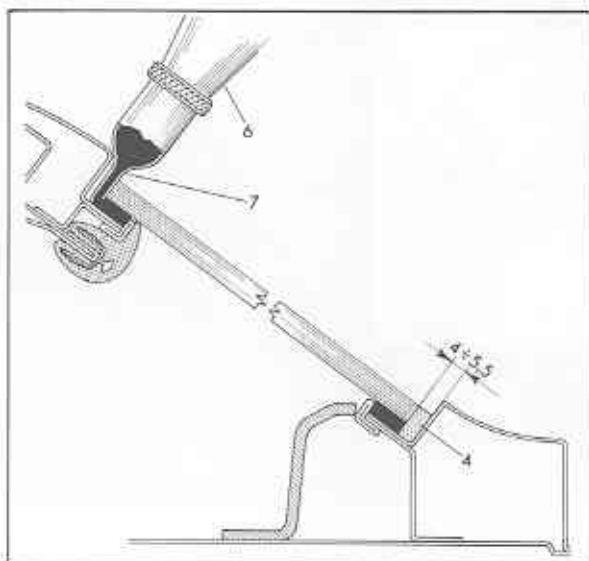



Press the screen into the aperture, using the adjustable strap 1 (G. 9.0003), suitably anchored to the edges of the rear wings. After approx. 30 minutes from application of adhesive, insert the 17 retaining clips 2 for the outer finisher into the bead of adhesive, arranging them as shown at page 12.

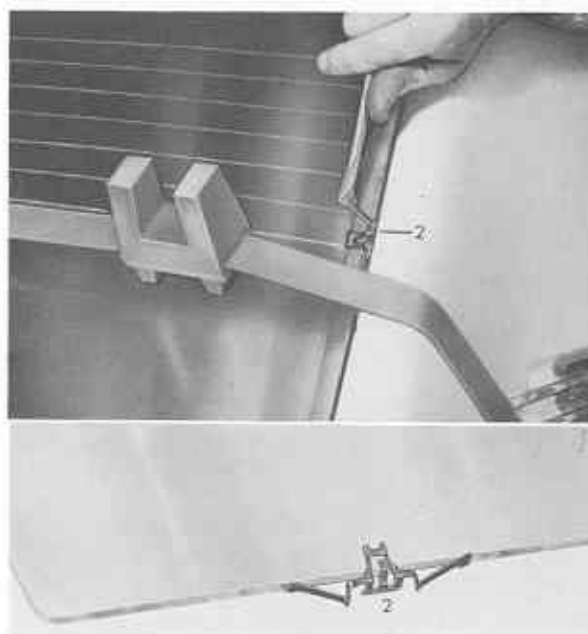

**NOTE:** Allow the adhesive to harden at room temperature for 6 to 8 hours, or for 12 to 18 hours, in the winter. At temperatures of 80°C, the hardening is completed in 60 minutes.

The car may be put in a low bake oven using the above temperature, providing the following precautions are taken.

- Drain petrol from tank
- Remove filler cap from tank and protect filler orifice with a paper cap that incorporates a breather slot.
- Lower tyre pressure
- Protect rear screen with asbestos.

Remove the screen compressing strap and scrape off any excess adhesive from the areas where the finisher is to be fitted.

Carry out water test. Any ingress of water can be rectified by applying a recommended sealant.

If usable, position, and clip the old top and bottom finishers in position, leaving the ends free. Clip the side finishers in the centre only. Lift the ends of the finishers, insert the joint covers 3 and complete the clipping.







Fit rear shelf and secure with its own screws. Using the recommended adhesive, glue the Texalfa strip 1 to the squab retaining panel. Fit squab, securing it with the wing nuts to the rear bulkhead. Fit rear seat.

**NOTE:** On cars fitted with heated rear screen, re-connect the ends of the two electric cables previously disconnected.

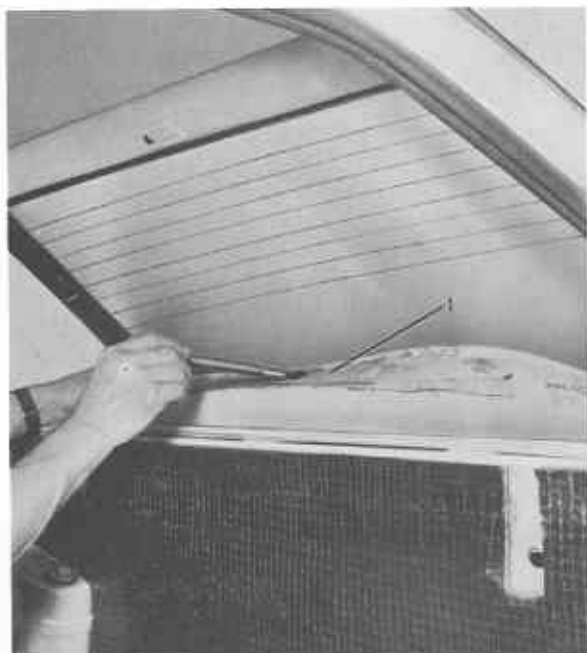

*Alfa Romeo*

Via Gattamelata, 45 - 20149 MILANO

DIASS - Public. n. 1982

5/75 - 1700  
Printed in Italy

All rights reserved. This book, or parts thereof, may not be reproduced in any form without permission of ALFA ROMEO S.p.A.